

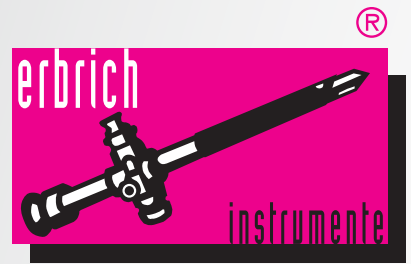















Quality made in Germany



Arthroskopie
Arthroscopy
Artroscopia







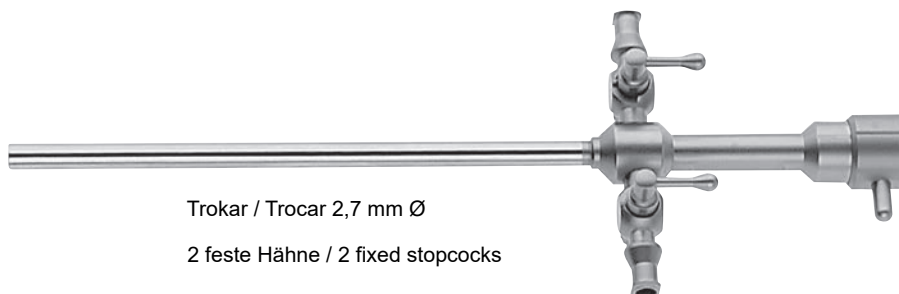









Trokar / Trocar 2,7 mm Ø
 1 fester Hahn / 1 fixed stopcock

	Arthroskop-Arbeitslänge		für Arthroskop
	Arthroscope working length		for Arthroscope
	69 mm	32E-100.00	32E-019.00
	69 mm	32E-100.10	32E-019.00/32E-019.03
	69 mm	32E-100.30	32E-019.00/32E-019.03
	102 mm	32E-101.00	32E-019.20
	102 mm	32E-101.10	32E-019.20/32E-019.23
	102 mm	32E-101.30	32E-019.20/32E-019.23
	110 mm	32E-102.00	32E-027.20
	110 mm	32E-102.10	32E-027.20/32E-027.23/32E-027.27
	110 mm	32E-102.30	32E-027.20/32E-027.23
	175 mm	32E-103.00	32E-027.10
	175 mm	32E-103.10	32E-027.10/32E-027.13/32E-027.17
	175 mm	32E-103.30	32E-027.10/32E-027.13
	187 mm	32E-104.00	32E-027.00
	187 mm	32E-104.10	32E-027.00/32E-027.03/32E-027.07
	187 mm	32E-104.30	32E-027.00/32E-027.03

















Trokar / Trocar 2,7 mm Ø

2 feste Hähne / 2 fixed stopcocks

	Arthroskop-Arbeitslänge		für Arthroskop
	Arthroscope working length		for Arthroscope
	69 mm	32E-110.00	32E-019.00
	69 mm	32E-110.10	32E-019.00/32E-019.03
	69 mm	32E-110.30	32E-019.00/32E-019.03
	102 mm	32E-111.00	32E-019.20
	102 mm	32E-111.10	32E-019.20/32E-019.23
	102 mm	32E-111.30	32E-019.20/32E-019.23
	110 mm	32E-112.00	32E-027.20
	110 mm	32E-112.10	32E-027.20/32E-027.23/32E-027.27
	110 mm	32E-112.30	32E-027.20/32E-027.23
	175 mm	32E-113.00	32E-027.10
	175 mm	32E-113.10	32E-027.10/32E-027.13/32E-027.17
	175 mm	32E-113.30	32E-027.10/32E-027.13
	187 mm	32E-114.00	32E-027.00
	187 mm	32E-114.10	32E-027.00/32E-027.03/32E-027.07
	187 mm	32E-114.30	32E-027.00/32E-027.03







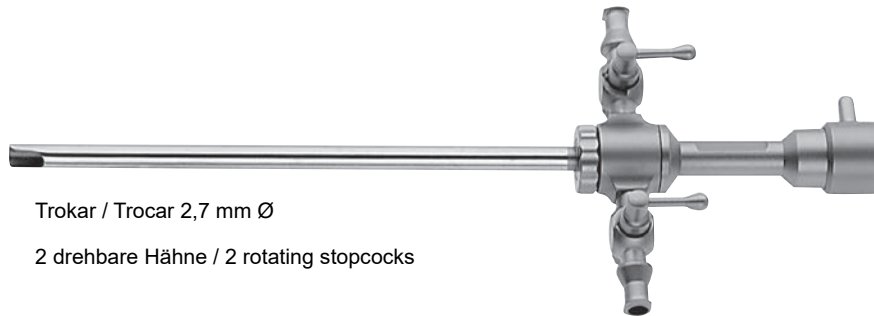









Trokar / Trocar 2,7 mm Ø
 1 drehbarer Hahn / 1 rotating stopcock

	Arthroskop-Arbeitslänge		für Arthroskop
	Arthroscope working length		for Arthroscope
	69 mm	32E-105.00	32E-019.00
	69 mm	32E-105.10	32E-019.00/32E-019.03
	69 mm	32E-105.30	32E-019.00/32E-019.03
	102 mm	32E-106.00	32E-019.20
	102 mm	32E-106.10	32E-019.20/32E-019.23
	102 mm	32E-106.30	32E-019.20/32E-019.23
	110 mm	32E-107.00	32E-027.20
	110 mm	32E-107.10	32E-027.20/32E-027.23/32E-027.27
	110 mm	32E-107.30	32E-027.20/32E-027.23
	175 mm	32E-108.00	32E-027.10
	175 mm	32E-108.10	32E-027.10/32E-027.13/32E-027.17
	175 mm	32E-108.30	32E-027.10/32E-027.13
	187 mm	32E-109.00	32E-027.00
	187 mm	32E-109.10	32E-027.00/32E-027.03/32E-027.07
	187 mm	32E-109.30	32E-027.00/32E-027.03





Trokar / Trocar 2,7 mm Ø
 2 drehbare Hähne / 2 rotating stopcocks

	Arthroskop-Arbeitslänge Arthroscope working length		für Arthroskop for Arthroscope
	69 mm	32E-115.00	32E-019.00
	69 mm	32E-115.10	32E-019.00/32E-019.03
	69 mm	32E-115.30	32E-019.00/32E-019.03
	102 mm	32E-116.00	32E-019.20
	102 mm	32E-116.10	32E-019.20/32E-019.23
	102 mm	32E-116.30	32E-019.20/32E-019.23
	110 mm	32E-117.00	32E-027.20
	110 mm	32E-117.10	32E-027.20/32E-027.23/32E-027.27
	110 mm	32E-117.30	32E-027.20/32E-027.23
	175 mm	32E-118.00	32E-027.10
	175 mm	32E-118.10	32E-027.10/32E-027.13/32E-027.17
	175 mm	32E-118.30	32E-027.10/32E-027.13
	187 mm	32E-119.00	32E-027.00
	187 mm	32E-119.10	32E-027.00/32E-027.03/32E-027.07
	187 mm	32E-119.30	32E-027.00/32E-027.03





Trokar / Trocar 4,0 mm Ø
 1 fester Hahn / 1 fixed stopcock

	Arthroskop-Arbeitslänge Arthroscope working length		für Arthroskop for Arthroscope
	175 mm	32E-120.00	32E-040.00
	175 mm	32E-120.10	32E-040.00/32E-040.03/32E-040.07
	175 mm	32E-120.30	32E-040.00/32E-040.03



highflow
 Trokar / Trocar 5,0 mm Ø
 1 fester Hahn / 1 fixed stopcock

	Arthroskop-Arbeitslänge Arthroscope working length		für Arthroskop for Arthroscope
	175 mm	32E-124.00	32E-040.00
	175 mm	32E-124.10	32E-040.00/32E-040.03/32E-040.07
	175 mm	32E-124.30	32E-040.00/32E-040.03

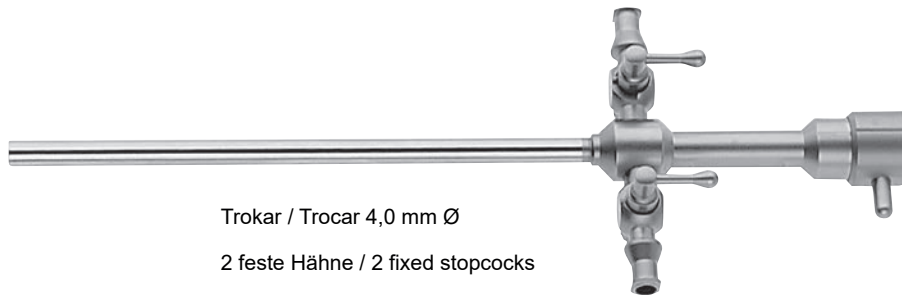

Trocar / Trocar 4,0 mm Ø
 2 feste Hähne / 2 fixed stopcocks



Arthroskop-Arbeitslänge
Arthroscope working length

für Arthroskop
for Arthroscope

175 mm **32E-122.00**

32E-040.00

175 mm **32E-122.10**

32E-040.00/32E-040.03/32E-040.07

175 mm **32E-122.30**

32E-040.00/32E-040.03

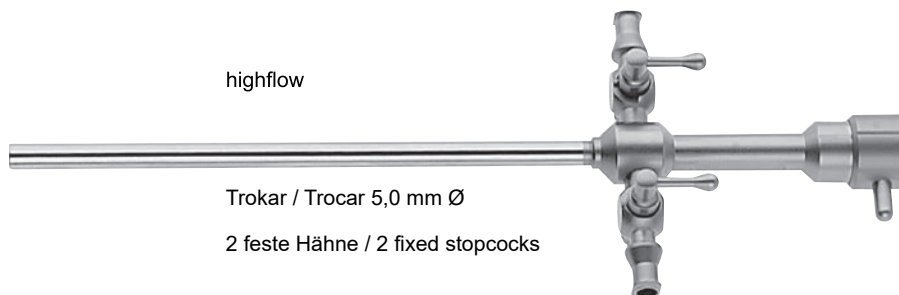

highflow
 Trocar / Trocar 5,0 mm Ø
 2 feste Hähne / 2 fixed stopcocks



Arthroskop-Arbeitslänge
Arthroscope working length

für Arthroskop
for Arthroscope

175 mm **32E-126.00**

32E-040.00

175 mm **32E-126.10**

32E-040.00/32E-040.03/32E-040.07

175 mm **32E-126.30**

32E-040.00/32E-040.03

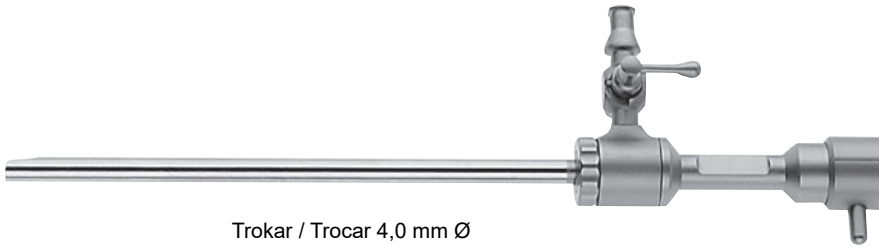

Trocar / Trocar 4,0 mm Ø
 1 drehbarer Hahn / 1 rotating stopcock



Arthroskop-Arbeitslänge Arthroscope working length		für Arthroskop for Arthroscope
175 mm	32E-121.00	32E-040.00
175 mm	32E-121.10	32E-040.00/32E-040.03/32E-040.07
175 mm	32E-121.30	32E-040.00/32E-040.03

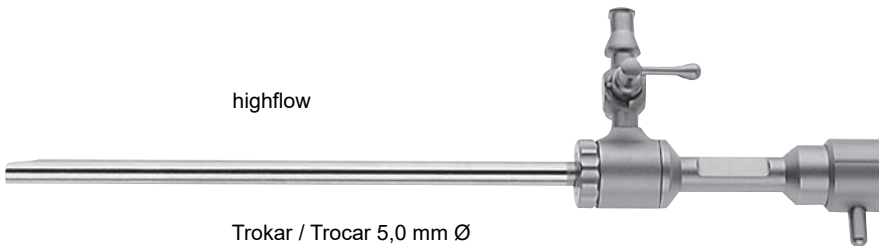

highflow
 Trocar / Trocar 5,0 mm Ø
 1 drehbarer Hahn / 1 rotating stopcock



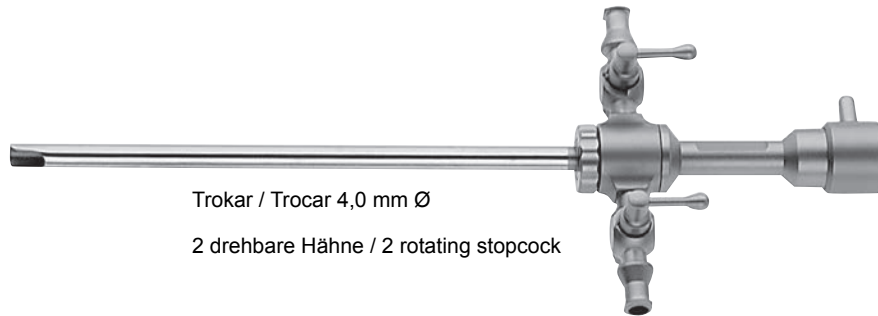

Arthroskop-Arbeitslänge Arthroscope working length		für Arthroskop for Arthroscope
175 mm	32E-125.00	32E-040.00
175 mm	32E-125.10	32E-040.00/32E-040.03/32E-040.07
175 mm	32E-125.30	32E-040.00/32E-040.03



Trocar / Trocar 4,0 mm Ø

2 drehbare Hähne / 2 rotating stopcock

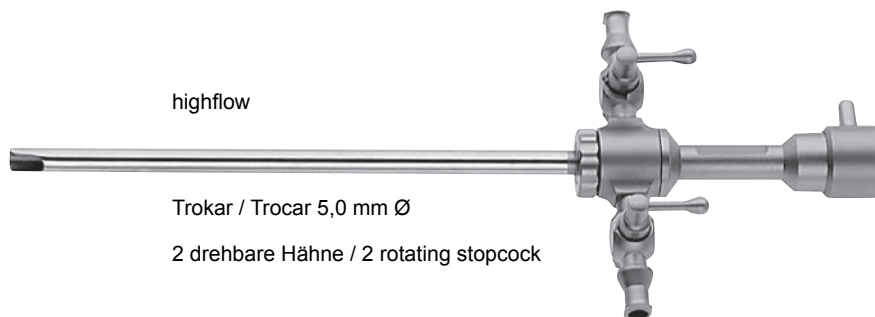

	Arthroskop-Länge Arthroscope-length		für Arthroskop for Arthroscope
	175 mm	32E-123.00	32E-040.00
	175 mm	32E-123.10	32E-040.00/32E-040.03/32E-040.07
	175 mm	32E-123.30	32E-040.00/32E-040.03



highflow

Trocar / Trocar 5,0 mm Ø

2 drehbare Hähne / 2 rotating stopcock

	Arthroskop-Länge Arthroscope-length		für Arthroskop for Arthroscope
	175 mm	32E-127.00	32E-040.00
	175 mm	32E-127.10	32E-040.00/32E-040.03/32E-040.07
	175 mm	32E-127.30	32E-040.00/32E-040.03



ø	Länge/length	
2,7 mm ø	69 mm	32E-100.21
2,7 mm ø	102 mm	32E-101.21
2,7 mm ø	110 mm	32E-102.21
2,7 mm ø	175 mm	32E-103.21
2,7 mm ø	187 mm	32E-104.21
4,0 mm ø	175 mm	32E-120.21
5,0 mm ø	175 mm	32E-124.21



ø	Länge/length	
2,7 mm ø	69 mm	32E-100.22
2,7 mm ø	102 mm	32E-101.22
2,7 mm ø	110 mm	32E-102.22
2,7 mm ø	175 mm	32E-103.22
2,7 mm ø	187 mm	32E-104.22
4,0 mm ø	175 mm	32E-120.22
5,0 mm ø	175 mm	32E-124.22



70 mm x 3,2 mm ø

32E-146.07



70 mm x 3,2 mm ø

32E-148.07

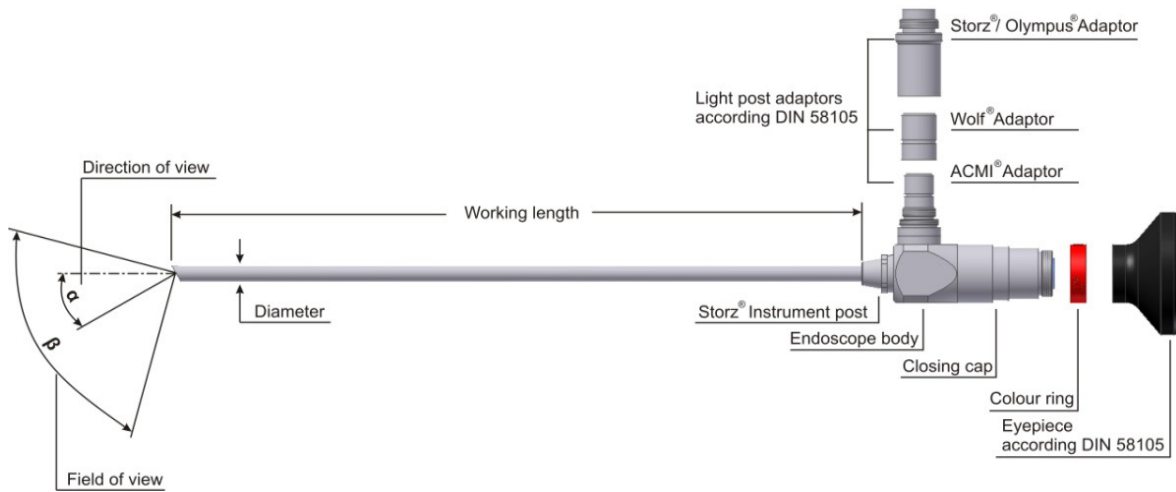

Sterilisation / Sterilization

Autoclavierbar max 134°, 21,2 bar, 5 min

Autoclavable max 134°, 2,2 bar, 5 min

Durchmesser / Diameter

1,9 mm 2,7 mm 4 mm

Blickrichtung / Direction of view



0°



30°



70°

Arbeitslänge / Working length

69 mm + 110 mm + 175 mm -

102,0 mm 187,5 mm 176 mm

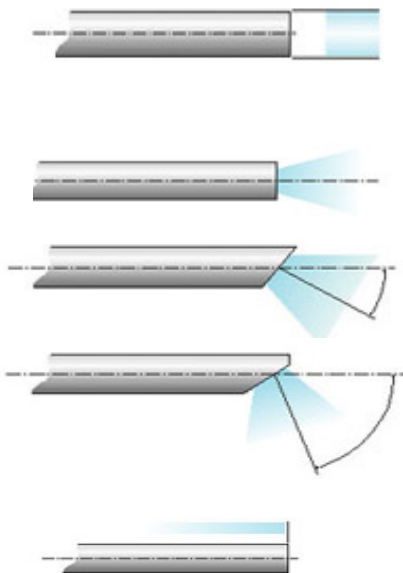



Grad	Durchmesser	Arbeitslänge	Artikel-Nummer
Direction of	Diameter	Working Length	Description
0°	1,9 mm	69 mm	32E-019.00
30°	1,9 mm	69 mm	32E-019.03
0°	1,9 mm	102 mm	32E-019.20
30°	1,9 mm	102 mm	32E-019.23
0°	2,7 mm	110 mm	32E-027.20
30°	2,7 mm	110 mm	32E-027.23
70°	2,7 mm	110 mm	32E-027.27
0°	2,7 mm	175 mm	32E-027.10
30°	2,7 mm	175,5 mm	32E-027.13
70°	2,7 mm	176 mm	32E-027.17
0°	2,7 mm	187,5 mm	32E-027.00
30°	2,7 mm	187,5 mm	32E-027.03
70°	2,7 mm	187,5 mm	32E-027.07
0°	4 mm	175 mm	32E-040.00
30°	4 mm	175,5 mm	32E-040.03
70°	4 mm	176 mm	32E-040.07



32E-150....



32E-150.02



32E-150.05



32E-150.08



32E-150.09



32E-150.12



32E-150.14



32E-150.16



32E-150.22



32E-150.26



32E-150.32



32E-150.38



32E-150.43



32E-150.46



11,5 x 6,5 mm
32E-150.60



11,5 x 6,5 mm
32E-150.62



32E-152.00



32E-152.02



32E-152.04



32E-152.06



32E-152.08



32E-152.10



32E-152.12



32E-152.14



32E-152.16



32E-152.18



32E-152.20



32E-152.22



32E-152.24



32E-152.26



32E-152.32



32E-152.33



32E-152.34



32E-152.38



32E-152.42



2,5 mm grad
32E-152.44



3,5 mm grad
32E-152.46



5,0 mm grad
32E-152.48



32E-152.50



32E-152.52



11,5 x 6,5 mm
32E-152.60



11,5 x 6,5 mm
32E-152.62

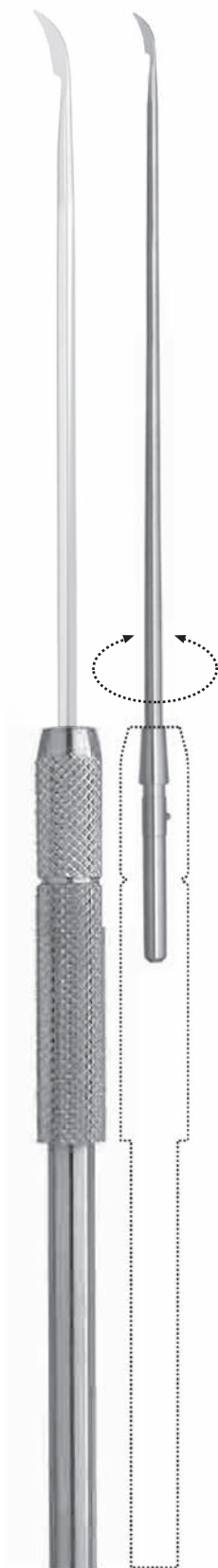

32E-154.00



32E-154.02



32E-154.04



32E-154.06



32E-154.08



32E-154.10



32E-154.12



32E-154.14



32E-154.16



32E-154.18



32E-154.20



32E-154.22



32E-152.24



32E-154.26



32E-154.32



32E-154.33



32E-154.34



32E-154.38



32E-154.42



2,5 mm grad
32E-154.44



3,5 mm grad
32E-154.46



5,0 mm grad
32E-154.48



11,5 x 6,5 mm
32E-154.60



11,5 x 6,5 mm
32E-154.62



32E-156. ...



32E-156.02



32E-156.04



32E-156.06



32E-156.08



32E-156.10



32E-156.12



32E-156.14



32E-156.16



32E-156.18



32E-156.20



32E-156.22



32E-156.24



32E-156.26



32E-156.32



32E-156.33



32E-156.34



32E-156.38



32E-156.42



3,0 mm
32E-156.45



5,0 mm
32E-156.47









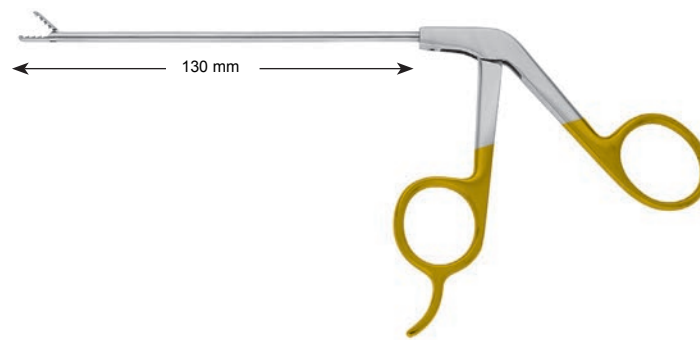





11,5 x 6,5 mm
32E-156.60



11,5 x 6,5 mm
32E-156.62



		Hakenschere Hook Scissors	Hakenstanze mit Schaufel Hook Punch with Scoop L = 5,0 mm · B = 1,6 mm	Hakenstanze abgesetzt Hook Punch set down L = 5,0 mm · B = 1,6 mm	Hakenstanze Schnitt eckig Hook Punch Cut angular L = 5,0 mm · B = 1,6 mm
	Ø				
	2,7	32E-501.02	32E-510.02	32E-511.02	
gerade · straight	3,5	32E-501.03	32E-510.03	32E-511.03	32E-512.03
	2,7	32E-501.12	32E-510.12	32E-511.12	
30° rechts · 30° right	3,5	32E-501.13	32E-510.13	32E-511.13	32E-512.13
	2,7	32E-501.22	32E-510.22	32E-511.22	
30° links · 30° left	3,5	32E-501.23	32E-510.23	32E-511.23	32E-512.23
	2,7	32E-501.32	32E-510.32	32E-511.32	
45° rechts · 45° right	3,5	32E-501.33	32E-510.33	32E-511.33	32E-512.33
	2,7	32E-501.42	32E-510.42	32E-511.42	
45° links · 45° left	3,5	32E-501.43	32E-510.43	32E-511.43	32E-512.43
	2,7	32E-501.52	32E-510.52	32E-511.52	
7° auf · 7° up	3,5	32E-501.53	32E-510.53	32E-511.53	32E-512.53
	2,7	32E-501.62	32E-510.62	32E-511.62	
7° ab · 7° down	3,5	32E-501.63	32E-510.63	32E-511.63	32E-512.63
	2,7	32E-501.72	32E-510.72	32E-511.72	
15° auf · 15° up	3,5	32E-501.73	32E-510.73	32E-511.73	32E-512.73
	2,7	32E-501.82	32E-510.82	32E-511.82	
15° ab · 15° down	3,5	32E-501.83	32E-510.83	32E-511.83	32E-512.83

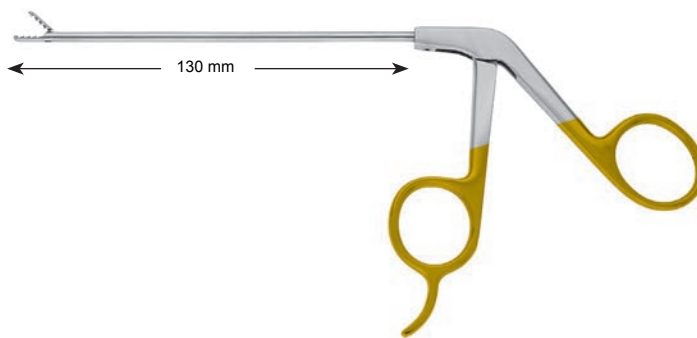

**Hakenstanze 15°
aufwärts gefräst
Hook Punch
15° up milled**

**Breitmaulstanze
groß
Wide Jaw Punch
large**

**Breitmaulstanze
mittel
Wide Jaw Punch
medium**

**Breitmaulstanze
klein
Wide Jaw Punch
small**

L = 5,0 mm · B = 1,6 mm









L = 5,0 mm · B = 4,5 mm

L = 5,0 mm · B = 3,5 mm

L = 6,0 mm · B = 2,5 mm

Ø



	2,7	32E-513.02			
gerade · straight	3,5	32E-513.03	32E-514.03	32E-515.03	32E-516.03
	2,7	32E-513.12			
30° rechts · 30° right	3,5	32E-513.13	32E-514.13	32E-515.13	32E-516.13
	2,7	32E-513.22			
30° links · 30° left	3,5	32E-513.23	32E-514.23	32E-515.23	32E-516.23
	2,7	32E-513.32			
45° rechts · 45° right	3,5	32E-513.33	32E-514.33	32E-515.33	32E-516.33
	2,7	32E-513.42			
45° links · 45° left	3,5	32E-513.43	32E-514.43	32E-515.43	32E-516.43
	2,7	32E-513.52			
7° auf · 7° up	3,5	32E-513.53	32E-514.53	32E-515.53	32E-516.53
	2,7	32E-513.62			
7° ab · 7° down	3,5	32E-513.63	32E-514.63	32E-515.63	32E-516.63
	2,7	32E-513.72			
15° auf · 15° up	3,5	32E-513.73	32E-514.73	32E-515.73	32E-516.73
	2,7	32E-513.82			
15° ab · 15° down	3,5	32E-513.83	32E-514.83	32E-515.83	32E-516.83

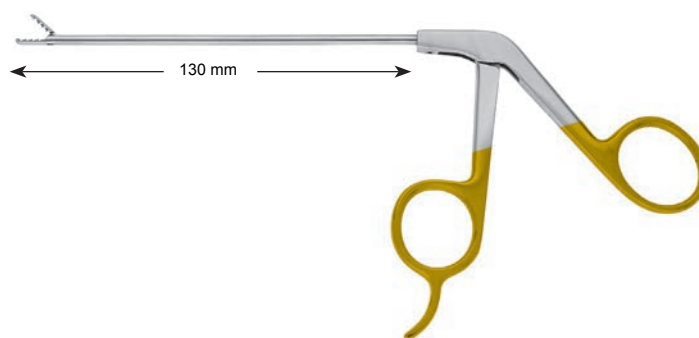

Breitmaulstanze groß
 15° aufwärts gefräst
 Wide Jaw Punch large
 15° up milled

Breitmaulstanze mittel
 15° aufwärts gefräst
 Wide Jaw Punch medium
 15° up milled

Breitmaulstanze klein
 15° aufwärts gefräst
 Wide Jaw Punch small
 15° up milled

Breitmaulstanze klein
 45° aufwärts gefräst
 Wide Jaw Punch small
 45° up milled

L = 5,0 mm · B = 4,5 mm

L = 5,0 mm · B = 3,5 mm

L = 6,0 mm · B = 2,5 mm

L = 6,0 mm · B = 2,0 mm

Ø



3,5

32E-517.03

32E-518.03

32E-519.03

32E-520.03

gerade · straight



3,5

32E-517.13

32E-518.13

32E-519.13

30° rechts · 30° right



3,5

32E-517.23

32E-518.23

32E-519.23

30° links · 30° left



3,5

32E-517.33

32E-518.33

32E-519.33

45° rechts · 45° right



3,5

32E-517.43

32E-518.43

32E-519.43

45° links · 45° left



3,5

32E-517.53

32E-518.53

32E-519.53

7° auf · 7° up



3,5

32E-517.63

32E-518.63

32E-519.63

7° ab · 7° down



3,5

32E-517.73

32E-518.73

32E-519.73

15° auf · 15° up



3,5

32E-517.83

32E-518.83

32E-519.83

15° ab · 15° down

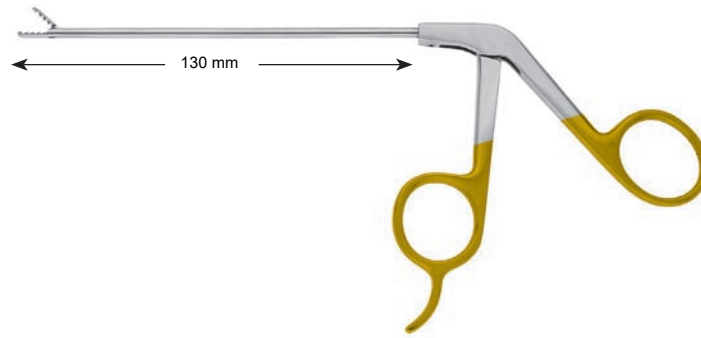

Scherenstanze
Scissors Punch

Scherenstanze
15° aufwärts gefräst
Scissors Punch
15° up milled

Stanze Retrograd
Schnitt links
Punch Retrograde
Cut left

Stanze Retrograd
Schnitt rechts
Punch Retrograde
Cut right

L = 5,0 mm · B = 0,8 mm

L = 5,0 mm · B = 0,8 mm

L = 4,0 mm · B = 2,5 mm

L = 4,0 mm · B = 2,5 mm

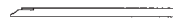

gerade · straight

Ø

3,5

32E-521.03

32E-522.03

32E-523.03

32E-524.03



30° rechts · 30° right

3,5

32E-521.13

32E-522.13



30° links · 30° left

3,5

32E-521.23

32E-522.23

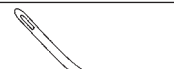

45° rechts · 45° right

3,5

32E-521.33

32E-522.33



45° links · 45° left

3,5

32E-521.43

32E-522.43



7° auf · 7° up

3,5

32E-521.53

32E-522.53



7° ab · 7° down

3,5

32E-521.63

32E-522.63



15° auf · 15° up

3,5

32E-521.73

32E-522.73



15° ab · 15° down

3,5

32E-521.83

32E-522.83

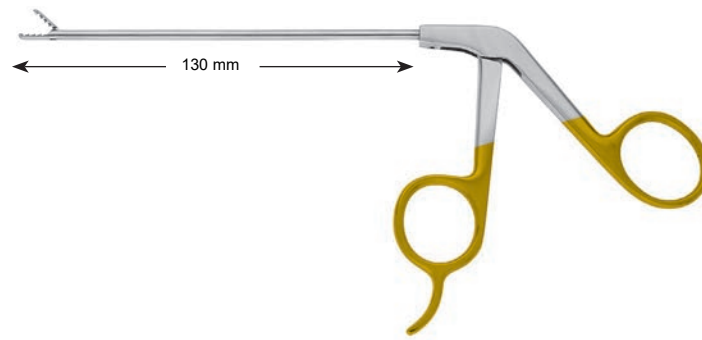

45° Hakenstanze
 45° Hook Scissors

45° Stanze
 mit Schaufel
 45° Punch
 with Scoop

45° Stanze
 stumpf
 45° Punch
 blunt

90° Stanze
 mit Schaufel
 90° Punch
 with Scoop

90° Stanze
 stumpf
 90° Punch
 blunt

L = 4,5 mm · B = 1,6 mm

L = 4,5 mm · B = 1,6 mm

L = 4,5 mm · B = 1,6 mm

L = 4,5 mm · B = 1,6 mm

Ø



rechts abgewinkelt
 right angled

3,5

32E-525.33

32E-526.33

32E-527.33

32E-528.33

32E-529.33

links abgewinkelt
 left angled

3,5

32E-525.43

32E-526.43

32E-527.43

32E-528.43

32E-529.43

90° Breitmaulstanze
 mittel
 90° Wide Jaw Punch
 medium

90° Breitmaulstanze
 klein
 90° Wide Jaw Punch
 small

L = 7,0 mm · B = 3,0 mm

L = 7,0 mm · B = 1,8 mm

Ø



rechts abgewinkelt
 right angled

3,5

32E-530.33

32E-531.33





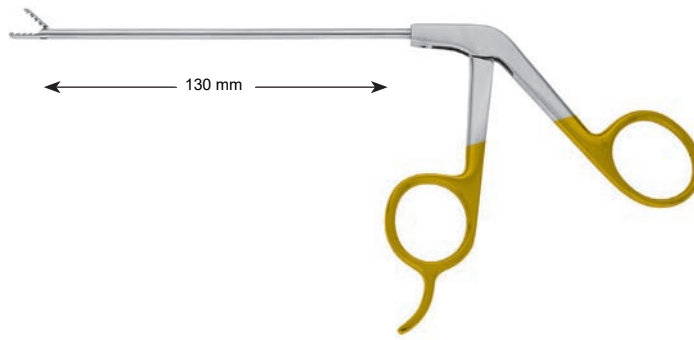

links abgewinkelt
 left angled

3,5





32E-530.43

32E-531.43

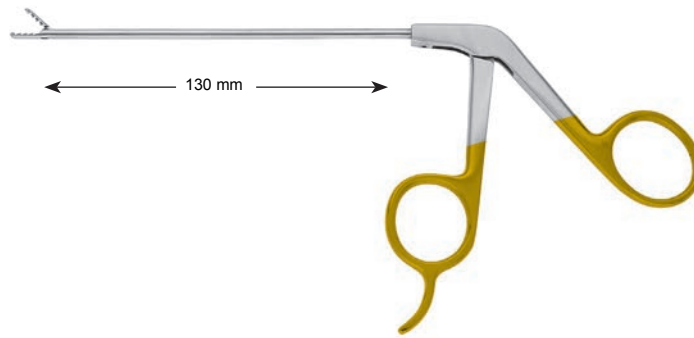







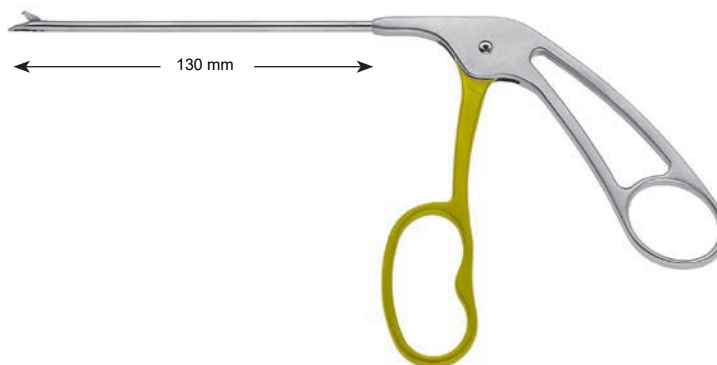





	Fasszange Grasping Forceps	Fasszange 1 x 2 Zähne, fein Grasping Forceps 1 x 2 Teeth, fine	Fasszange 1 x 2 Zähne, grob Grasping Forceps 1 x 2 Teeth, crass
Ø			
2,7	32E-550.02		
3,5	32E-550.03	32E-551.03	32E-552.03
	Fass- und Biopsiezange Grasping and Biopsy Forceps	Biopsie-Löffel- Zange Biopsy Spoon Forceps	Bulldog -Fasszange 1x2 Zähne, grob Bulldog -Grasping Forceps 1x2 teeth, crass
Ø			
3,5	32E-553.03	32E-554.03	
4,5			32E-555.04

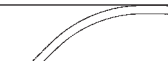

	Fadenfasszange gerade Suture Grasping Forceps	Arthro-Stecker 45° scharf aufwärts gefräst Suture-Pierce 45° sharp up milled	Arthro-Stecker 10° scharf aufwärts gefräst Suture-Pierce 10° sharp up milled	Arthro-Stecker scharf gerade Suture-Pierce sharp straight
Ø				
3,5	32E-570.03	32E-571.03	32E-572.03	32E-573.03



		Hakenschere Hook Scissors	Hakenstanze mit Schaufel Hook Punch with Scoop	Hakenstanze abgesetzt Hook Punch set down	Hakenstanze Schnitt eckig Hook Punch Cut angular
	Ø		L = 5,0 mm · B = 1,6 mm	L = 5,0 mm · B = 1,6 mm	L = 5,0 mm · B = 1,6 mm
	2,7				
gerade · straight	3,5	32E-701.02	32E-710.02	32E-711.02	32E-712.03
		32E-701.03	32E-710.03	32E-711.03	32E-712.03
	2,7	32E-701.12	32E-710.12	32E-711.12	
30° rechts · 30° right	3,5	32E-701.13	32E-710.13	32E-711.13	32E-712.13
	2,7	32E-701.22	32E-710.22	32E-711.22	
30° links · 30° left	3,5	32E-701.23	32E-710.23	32E-711.23	32E-712.23
	2,7	32E-701.32	32E-710.32	32E-711.32	
45° rechts · 45° right	3,5	32E-701.33	32E-710.33	32E-711.33	32E-712.33
	2,7	32E-701.42	32E-710.42	32E-711.42	
45° links · 45° left	3,5	32E-701.43	32E-710.43	32E-711.43	32E-712.43
	2,7	32E-701.52	32E-710.52	32E-711.52	
7° auf · 7° up	3,5	32E-701.53	32E-710.53	32E-711.53	32E-712.53
	2,7	32E-701.62	32E-710.62	32E-711.62	
7° ab · 7° down	3,5	32E-701.63	32E-710.63	32E-711.63	32E-712.63
	2,7	32E-701.72	32E-710.72	32E-711.72	
15° auf · 15° up	3,5	32E-701.73	32E-710.73	32E-711.73	32E-712.73
	2,7	32E-701.82	32E-710.82	32E-711.82	
15° ab · 15° down	3,5	32E-701.83	32E-710.83	32E-711.83	32E-712.83

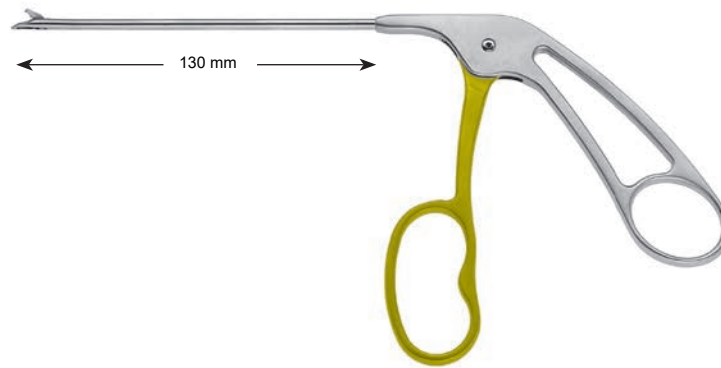

**Hakenstanze 15°
aufwärts geätzt
Hook Punch
15° up milled**

L = 5,0 mm · B = 1,6 mm



**Breitmaulstanze
groß
Wide Jaw Punch
large**

L = 5,0 mm · B = 4,5 mm



**Breitmaulstanze
mittel
Wide Jaw Punch
medium**

L = 5,0 mm · B = 3,5 mm



**Breitmaulstanze
klein
Wide Jaw Punch
small**

L = 6,0 mm · B = 2,5 mm



Ø



2,7

32E-713.02

gerade · straight

3,5

32E-713.03

32E-714.03

32E-715.03

32E-716.03



2,7

32E-713.12

30° rechts · 30° right

3,5

32E-713.13

32E-714.13

32E-715.13

32E-716.13



2,7

32E-713.22

30° links · 30° left

3,5

32E-713.23

32E-714.23

32E-715.23

32E-716.23



2,7

32E-713.32

3,5

32E-713.33

32E-714.33

32E-715.33

32E-716.33



2,7

32E-713.42

45° links · 45° left

3,5

32E-713.43

32E-714.43

32E-715.43

32E-716.43



2,7

32E-713.52

7° auf · 7° up

3,5

32E-713.53

32E-714.53

32E-715.53

32E-716.53



2,7

32E-713.62

7° ab · 7° down

3,5

32E-713.63

32E-714.63

32E-715.63

32E-716.63



2,7

32E-713.72

15° auf · 15° up

3,5

32E-713.73

32E-714.73

32E-715.73

32E-716.73



2,7

32E-713.82

15° ab · 15° down

3,5

32E-713.83

32E-714.83

32E-715.83

32E-716.83

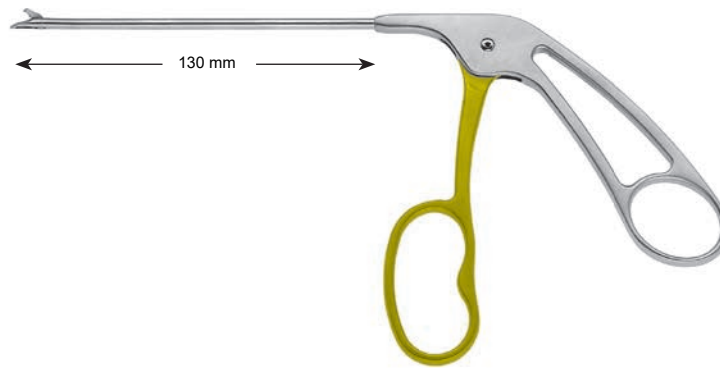













Breitmaulstanze groß
 15° aufwärts gefräst
 Wide Jaw Punch large
 15° up milled
 L = 5,0 mm · B = 4,5 mm









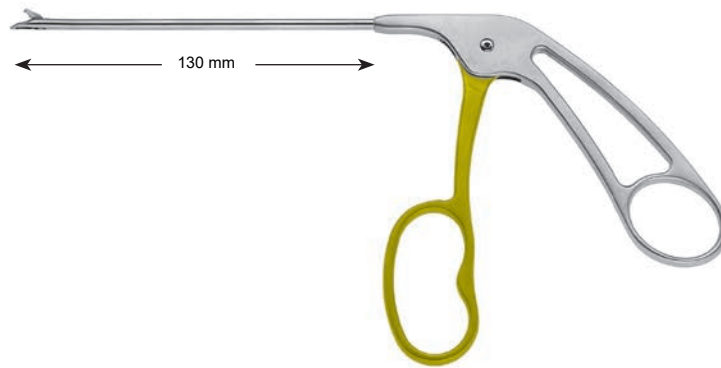



Breitmaulstanze mittel
 15° aufwärts gefräst
 Wide Jaw Punch medium
 15° up milled
 L = 5,0 mm · B = 3,5 mm

Breitmaulstanze klein
 15° aufwärts gefräst
 Wide Jaw Punch small
 15° up milled
 L = 6,0 mm · B = 2,5 mm

Breitmaulstanze klein
 45° aufwärts gefräst
 Wide Jaw Punch small
 45° up milled
 L = 6,0 mm · B = 2,0 mm

	Ø				
 gerade · straight	3,5	32E-717.03	32E-718.03	32E-719.03	32E-720.03
 30° rechts · 30° right	3,5	32E-717.13	32E-718.13	32E-719.13	
 30° links · 30° left	3,5	32E-717.23	32E-718.23	32E-719.23	
 45° rechts · 45° right	3,5	32E-717.33	32E-718.33	32E-719.33	
 45° links · 45° left	3,5	32E-717.43	32E-718.43	32E-719.43	
 7° auf · 7° up	3,5	32E-717.53	32E-718.53	32E-719.53	
 7° ab · 7° down	3,5	32E-717.63	32E-718.63	32E-719.63	
 15° auf · 15° up	3,5	32E-717.73	32E-718.73	32E-719.73	
 15° ab · 15° down	3,5	32E-717.83	32E-718.83	32E-719.83	



		Scherenstanze Scissors Punch	Scherenstanze 15° aufwärts gefräst Scissors Punch 15° up milled	Stanze Retrograd Schnitt links Punch Retrograde Cut left	Stanze Retrograd Schnitt rechts Punch Retrograde Cut right
		L = 5,0 mm · B = 0,8 mm	L = 5,0 mm · B = 0,8 mm	L = 4,0 mm · B = 2,5 mm	L = 4,0 mm · B = 2,5 mm
	Ø				
gerade · straight	3,5	32E-721.03	32E-722.03	32E-723.03	32E-724.03
	3,5	32E-721.13	32E-722.13		
30° rechts · 30° right					
	3,5	32E-721.23	32E-722.23		
30° links · 30° left					
	3,5	32E-721.33	32E-722.33		
45° rechts · 45° right					
	3,5	32E-721.43	32E-722.43		
45° links · 45° left					
	3,5	32E-721.53	32E-722.53		
7° auf · 7° up					
	3,5	32E-721.63	32E-722.63		
7° ab · 7° down					
	3,5	32E-721.73	32E-722.73		
15° auf · 15° up					
	3,5	32E-721.83	32E-722.83		
15° ab · 15° down					

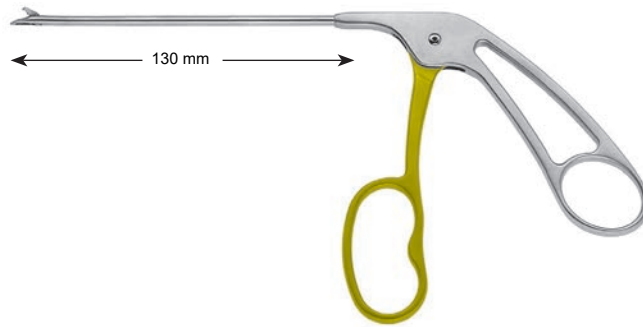

45° Hakenstanze
 45° Hook Scissors

45° Stanze
 mit Schaufel
 45° Punch
 with Scoop
 L = 4,5 mm · B = 1,6 mm

45° Stanze
 stumpf
 45° Punch
 blunt
 L = 4,5 mm · B = 1,6 mm

90° Stanze
 mit Schaufel
 90° Punch
 with Scoop
 L = 4,5 mm · B = 1,6 mm

90° Stanze
 stumpf
 90° Punch
 blunt
 L = 4,5 mm · B = 1,6 mm

Ø



rechts abgewinkelt
 right angled

3,5

32E-725.33

32E-726.33

32E-727.33

32E-728.33

32E-729.33

links abgewinkelt
 left angled

3,5

32E-725.43

32E-726.43

32E-727.43

32E-728.43

32E-729.43

90° Breitmaulstanze
 mittel
 90° Wide Jaw Punch
 medium

L = 7,0 mm · B = 3,0 mm



32E-730.33

90° Breitmaulstanze
 klein
 90° Wide Jaw Punch
 small

L = 7,0 mm · B = 1,8 mm



32E-731.33

rechts abgewinkelt
 right angled

3,5

links abgewinkelt
 left angled

3,5

32E-730.43

32E-731.43

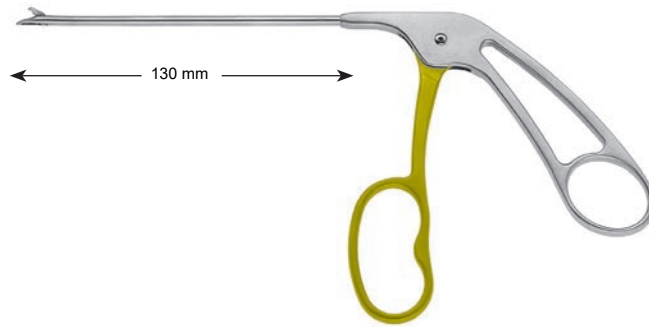

Fasszange
 Grasping Forceps



Ø

2,7 32E-750.02

Fasszange
 1 x 2 Zähne, fein
 Grasping Forceps
 1 x 2 Teeth, fine



32E-751.03

Fasszange
 1 x 2 Zähne, grob
 Grasping Forceps
 1 x 2 Teeth, crass



32E-752.03

Fass- und
 Biopsiezange
 Grasping and
 Biopsy Forceps



Ø

3,5 32E-753.03

Biopsie-Löffel-
 Zange
 Biopsy Spoon
 Forceps



32E-754.03

Bulldog -Fasszange
 1x2 Zähne, grob
 Bulldog -Grasping
 Forceps
 1x2 teeth, crass







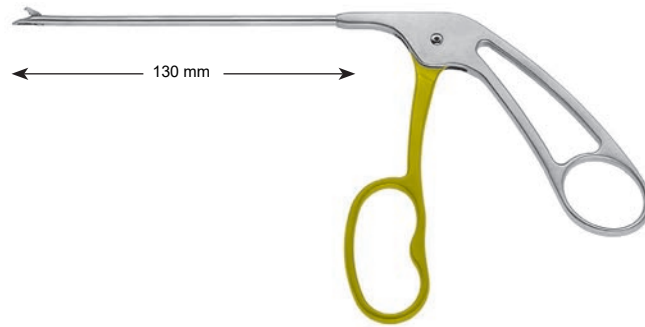



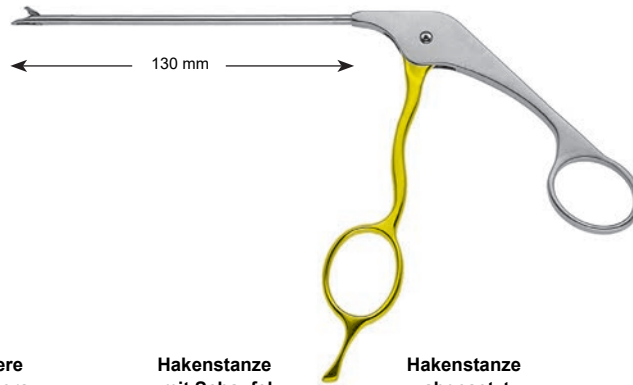





32E-755.04

4,5



	Fadenfasszange gerade Suture Grasping Forceps	Arthro-Stecker 45° scharf aufwärts gefräst Suture-Pierce 45° sharp up milled	Arthro-Stecker 10° scharf aufwärts gefräst Suture-Pierce 10° sharp up milled	Arthro-Stecker scharf gerade Suture-Pierce sharp straight
Ø				
3,5	32E-770.03	32E-771.03	32E-772.03	32E-773.03



		Hakenschere Hook Scissors	Hakenstanze mit Schaufel Hook Punch with Scoop	Hakenstanze abgesetzt Hook Punch set down	Hakenstanze Schnitt eckig Hook Punch Cut angular
			L = 5,0 mm · B = 1,6 mm	L = 5,0 mm · B = 1,6 mm	L = 5,0 mm · B = 1,6 mm
	Ø				
	2,7	32E-901.02	32E-910.02	32E-911.02	
	3,5	32E-901.03	32E-910.03	32E-911.03	32E-912.03
gerade · straight					
	2,7	32E-901.12	32E-910.12	32E-911.12	
	3,5	32E-901.13	32E-910.13	32E-911.13	32E-912.13
30° rechts · 30° right					
	2,7	32E-901.22	32E-910.22	32E-911.22	
	3,5	32E-901.23	32E-910.23	32E-911.23	32E-912.23
30° links · 30° left					
	2,7	32E-901.32	32E-910.32	32E-911.32	
	3,5	32E-901.33	32E-910.33	32E-911.33	32E-912.33
45° rechts · 45° right					
	2,7	32E-901.42	32E-910.42	32E-911.42	
	3,5	32E-901.43	32E-910.43	32E-911.43	32E-912.43
45° links · 45° left					
	2,7	32E-901.52	32E-910.52	32E-911.52	
	3,5	32E-901.53	32E-910.53	32E-911.53	32E-912.53
7° auf · 7° up					
	2,7	32E-901.62	32E-910.62	32E-911.62	
	3,5	32E-901.63	32E-910.63	32E-911.63	32E-912.63
7° ab · 7° down					
	2,7	32E-901.72	32E-910.72	32E-911.72	
	3,5	32E-901.73	32E-910.73	32E-911.73	32E-912.73
15° auf · 15° up					
	2,7	32E-901.82	32E-910.82	32E-911.82	
	3,5	32E-901.83	32E-910.83	32E-911.83	32E-912.83
15° ab · 15° down					

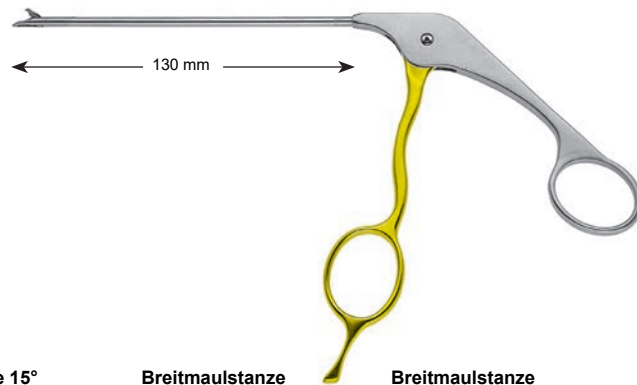

**Hakenstanze 15°
aufwärts geätzt**
**Hook Punch
15° up milled**

L = 5,0 mm · B = 1,6 mm



**Breitmaulstanze
groß**
**Wide Jaw Punch
large**

L = 5,0 mm · B = 4,5 mm



**Breitmaulstanze
mittel**
**Wide Jaw Punch
medium**









L = 5,0 mm · B = 3,5 mm

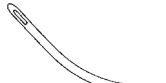

**Breitmaulstanze
klein**
**Wide Jaw Punch
small**

L = 6,0 mm · B = 2,5 mm



	Ø				
	2,7	32E-913.02			
gerade · straight	3,5	32E-913.03	32E-914.03	32E-915.03	32E-916.03
	2,7	32E-913.12			
30° rechts · 30° right	3,5	32E-913.13	32E-914.13	32E-915.13	32E-916.13
	2,7	32E-913.22			
30° links · 30° left	3,5	32E-913.23	32E-914.23	32E-915.23	32E-916.23
	2,7	32E-913.32			
45° rechts · 45° right	3,5	32E-913.33	32E-914.33	32E-915.33	32E-916.33
	2,7	32E-913.42			
45° links · 45° left	3,5	32E-913.43	32E-914.43	32E-915.43	32E-916.43
	2,7	32E-913.52			
7° auf · 7° up	3,5	32E-913.53	32E-914.53	32E-915.53	32E-916.53
	2,7	32E-913.62			
7° ab · 7° down	3,5	32E-913.63	32E-914.63	32E-915.63	32E-916.63
	2,7	32E-913.72			
15° auf · 15° up	3,5	32E-913.73	32E-914.73	32E-915.73	32E-916.73
	2,7	32E-913.82			
15° ab · 15° down	3,5	32E-913.83	32E-914.83	32E-915.83	32E-916.83

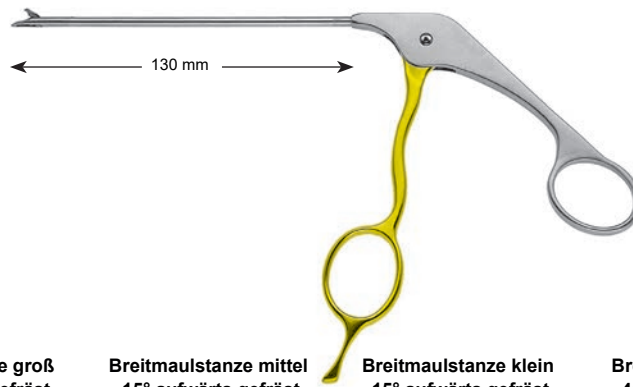

Breitmaulstanze groß
 15° aufwärts gefräst
 Wide Jaw Punch large
 15° up milled

L = 5,0 mm · B = 4,5 mm



Breitmaulstanze mittel
 15° aufwärts gefräst
 Wide Jaw Punch medium
 15° up milled

L = 5,0 mm · B = 3,5 mm



Breitmaulstanze klein
 15° aufwärts gefräst
 Wide Jaw Punch small
 15° up milled

L = 6,0 mm · B = 2,5 mm



Breitmaulstanze klein
 45° aufwärts gefräst
 Wide Jaw Punch small
 45° up milled

L = 6,0 mm · B = 2,0 mm



Ø



gerade · straight

3,5

32E-917.03

32E-918.03

32E-919.03

32E-920.03



30° rechts · 30° right

3,5

32E-917.13

32E-918.13

32E-919.13



30° links · 30° left

3,5

32E-917.23

32E-918.23

32E-919.23

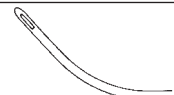

45° rechts · 45° right

3,5

32E-917.33

32E-918.33

32E-919.33



45° links · 45° left

3,5

32E-917.43

32E-918.43

32E-919.43



7° auf · 7° up

3,5

32E-917.53

32E-918.53

32E-919.53

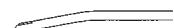

7° ab · 7° down

3,5

32E-917.63

32E-918.63

32E-919.63



15° auf · 15° up

3,5

32E-917.73

32E-918.73

32E-919.73



15° ab · 15° down

3,5

32E-917.83

32E-918.83

32E-919.83

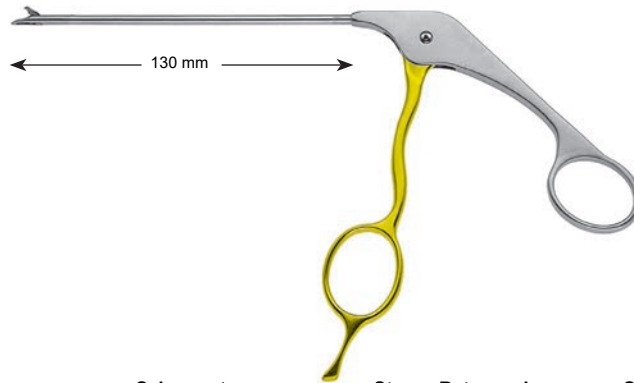

Scherenstanze
Scissors Punch

L = 5,0 mm · B = 0,8 mm



Scherenstanze
15° aufwärts gefräst
Scissors Punch
15° up milled

L = 5,0 mm · B = 0,8 mm



Stanze Retrograd
Schnitt links
Punch Retrograde
Cut left

L = 4,0 mm · B = 2,5 mm



Stanze Retrograd
Schnitt rechts
Punch Retrograde
Cut right

L = 4,0 mm · B = 2,5 mm



Ø



gerade · straight

3,5

32E-921.03

32E-922.03

32E-923.03

32E-924.03

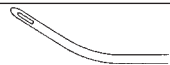

30° rechts · 30° right

3,5

32E-921.13

32E-922.13



30° links · 30° left

3,5

32E-921.23

32E-922.23



45° rechts · 45° right

3,5

32E-921.33

32E-922.33



45° links · 45° left

3,5

32E-921.43

32E-922.43

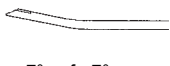

7° auf · 7° up

3,5

32E-921.53

32E-922.53



7° ab · 7° down

3,5

32E-921.63

32E-922.63

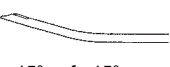

15° auf · 15° up

3,5

32E-921.73

32E-922.73



15° ab · 15° down

3,5

32E-921.83

32E-922.83

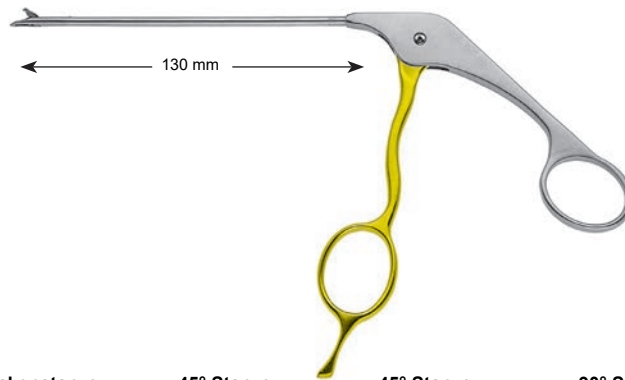

45° Hakenstanze
 45° Hook Scissors

45° Stanze
 mit Schaufel
 45° Punch
 with Scoop

45° Stanze
 stumpf
 45° Punch
 blunt

90° Stanze
 mit Schaufel
 90° Punch
 with Scoop

90° Stanze
 stumpf
 90° Punch
 blunt

L = 4,5 mm · B = 1,6 mm

L = 4,5 mm · B = 1,6 mm

L = 4,5 mm · B = 1,6 mm

L = 4,5 mm · B = 1,6 mm

Ø

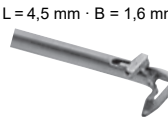
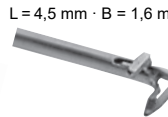

rechts abgewinkelt
 right angled

3,5

32E-925.33

32E-926.33

32E-927.33

32E-928.33

32E-929.33

links abgewinkelt
 left angled

3,5

32E-925.43

32E-926.43

32E-927.43

32E-928.43

32E-929.43

90° Breitmaulstanze
 mittel
 90° Wide Jaw Punch
 medium

90° Breitmaulstanze
 klein
 90° Wide Jaw Punch
 small

L = 7,0 mm · B = 3,0 mm

L = 7,0 mm · B = 1,8 mm

Ø



rechts abgewinkelt
 right angled

3,5

32E-930.33

32E-931.33

links abgewinkelt
 left angled

3,5

32E-930.43

32E-931.43

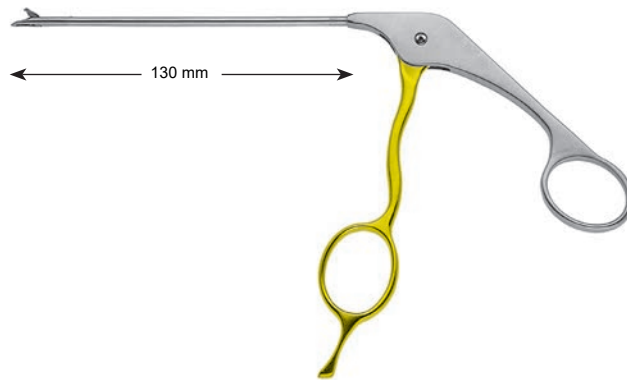

Fasszange
Grasping Forceps



Ø

2,7

32E-950.02

Fasszange
1 x 2 Zähne, fein
Grasping Forceps
1 x 2 Teeth, fine



3,5

32E-950.03

Fasszange
1 x 2 Zähne, grob
Grasping Forceps
1 x 2 Teeth, crass



32E-951.03

32E-952.03

Fass- und
Biopsiezange
Grasping and
Biopsy Forceps



Ø

3,5

32E-953.03

Biopsie-Löffel-
Zange
Biopsy Spoon
Forceps



32E-954.03





Bulldog -Fasszange
1x2 Zähne, grob
Bulldog -Grasping
Forceps
1x2 teeth, crass

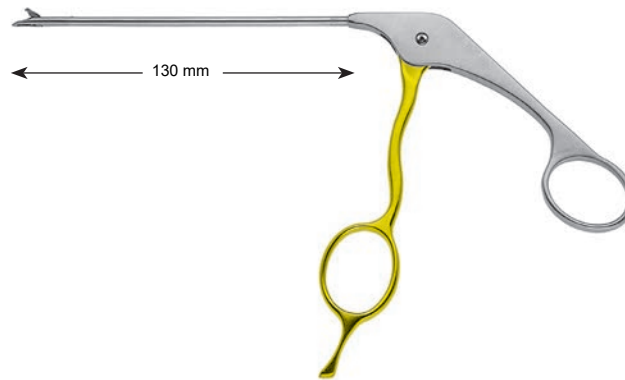

4,5

32E-955.04



	Fadenfasszange gerade Suture Grasping Forceps	Arthro-Stecker 45° scharf aufwärts gefräst Suture-Pierce 45° sharp up milled	Arthro-Stecker 10° scharf aufwärts gefräst Suture-Pierce 10° sharp up milled	Arthro-Stecker scharf gerade Suture-Pierce sharp straight
Ø				
3,5	32E-970.03	32E-971.03	32E-972.03	32E-973.03

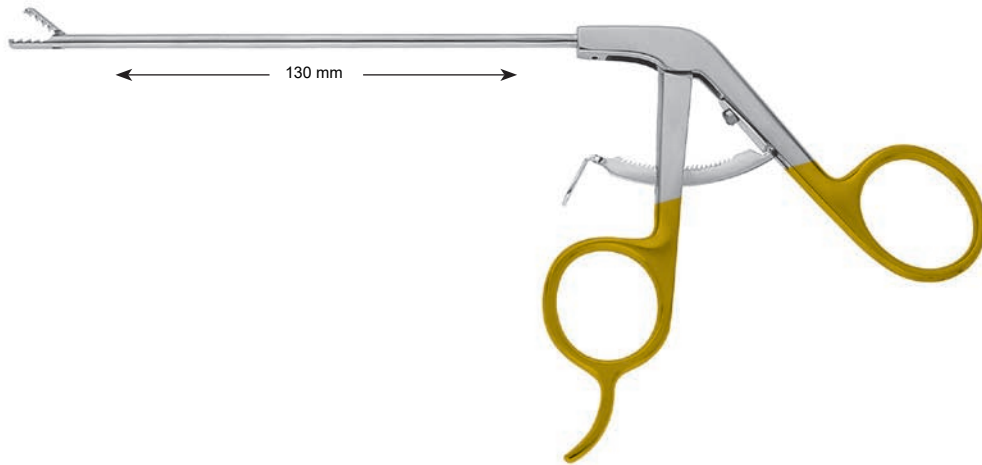

	Fasszange Grasping Forceps	Fasszange 1 x 2 Zähne, fein Grasping Forceps 1 x 2 Teeth, fine	Fasszange 1 x 2 Zähne, grob Grasping Forceps 1 x 2 Teeth, crass
Ø			
2,7	32E-850.02		
3,5	32E-850.03	32E-851.03	32E-852.03
	Fass- und Biopsiezange Grasping and Biopsy Forceps	Biopsie-Löffel- Zange Biopsy Spoon Forceps	Bulldog -Fasszange 1x2 Zähne, grob Bulldog -Grasping Forceps 1x2 teeth, crass
Ø			
3,5	32E-853.03	32E-854.03	
4,5			32E-855.04

**32E-296.01**

Axiale Fasszange
Axial Grasping Forceps

gerade · straight

mit Sperre · with ratchet

Länge 19,0 cm · length 19,0 cm

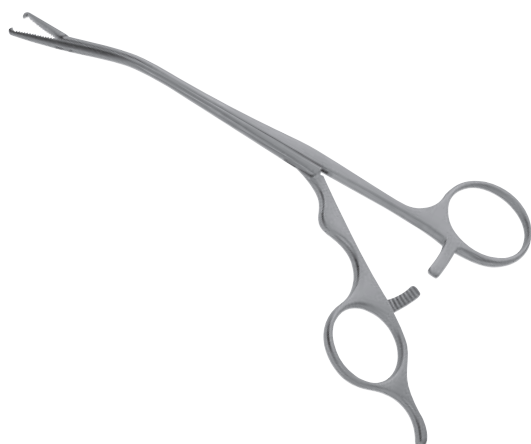
**32E-296.02**

Axiale Fasszange
Axial Grasping Forceps

rechts gebogen · right curved

mit Sperre · with ratchet

Länge 19,0 cm · length 19,0 cm

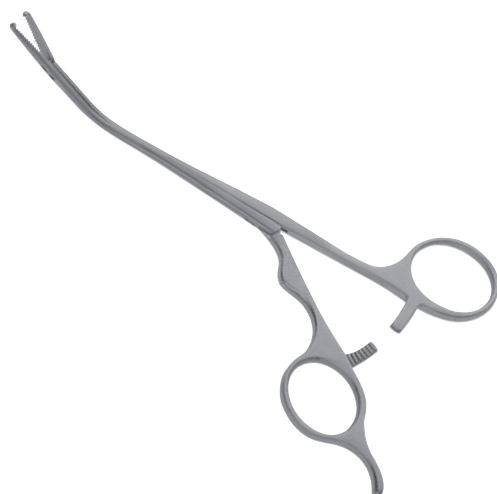
**32E-296.03**

Axiale Fasszange
Tendon Grasping Forceps

links gebogen · left curved

mit Sperre · with ratchet

Länge 19,0 cm · length 19,0 cm

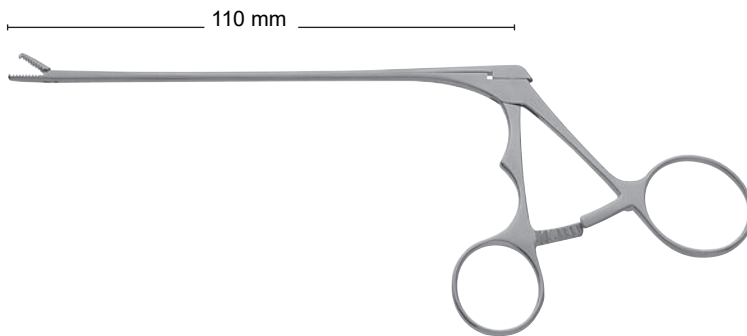

32E-293.11

Meniskus-Fasszange fein,
1x2 Zähne, gerade, Länge 110 mm, mit Sperre

Meniscus grasping forceps, fine
1x2 teeth, straight, length 110 mm, with ratchet

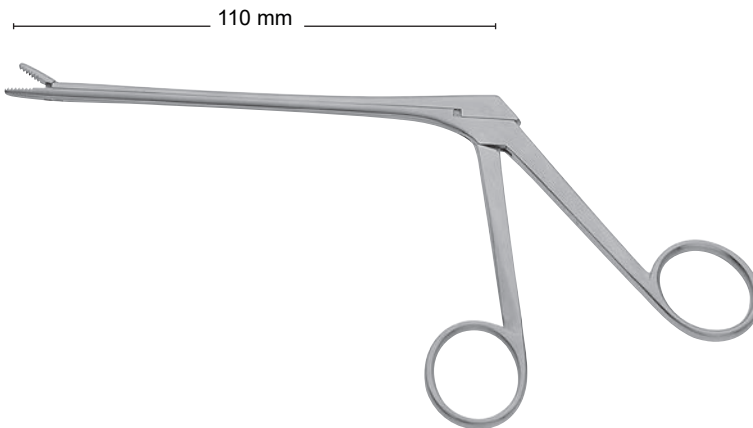

32E-294.14

Meniskus-Fasszange, kräftig, 4,2 mm Ø, Länge 110 mm

Meniscus Grasping Forceps, strong, 4,2 mm Ø,
length 110 mm

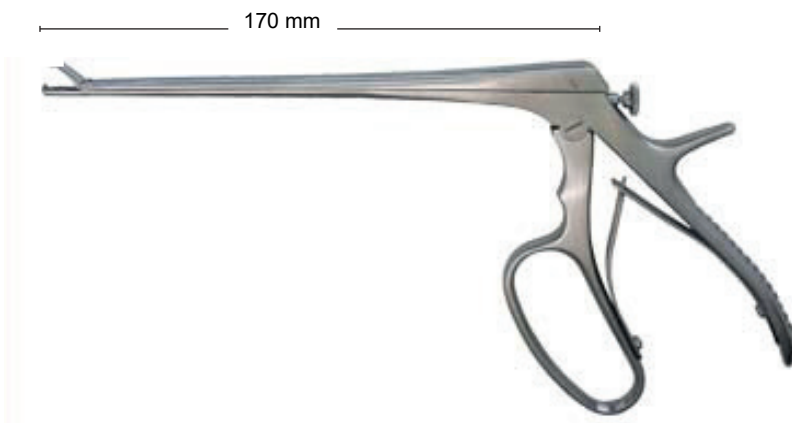

32E-295.17

Kerrison-Fasszange, fein gerieft
1x2 Zähne, gerade, Länge 170 mm, mit
Stellschraube

Kerrison Grasping Forceps, fine serrated 1x2 teeth
with screw

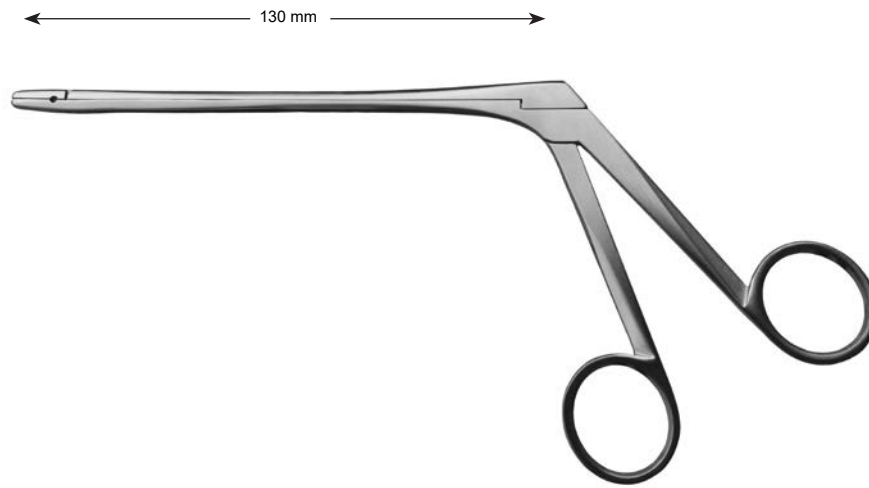

Schlesinger

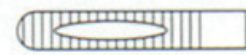

2 x 10 mm

32E-300.02



3 x 10 mm

32E-300.03



4 x 10 mm

32E-300.04

Die Arthroskopie-Elektroden sind wiederverwendbar (bis zu 5 x) und autoklavierbar (134° C)
 The Arthroscopic Electrodes are reusable (up to 5 times) and autoclavable (134° C)



Nadelelektrode / Needle electrode
 90° abgewinkelt, 1,5 mm, Ø 0,6 mm
 90° angled, 1,5 mm, Ø 0,6 mm

29E-620.01



Nadelelektrode / Needle electrode
 90° abgewinkelt, 4,0 mm, Ø 0,6 mm
 90° angled, 4,0 mm, Ø 0,6 mm

29E-620.02



Messerelektrode / Knife electrode
 45° abgewinkelt, 4,0 mm, Ø 1,5 mm
 45° angled, 4,0 mm, Ø 1,5 mm

29E-620.03



Tastelektrode / Button electrode
 90° abgewinkelt, 4,0 mm, Ø 1,5 mm
 90° angled, 4,0 mm, Ø 1,5 mm

29E-620.04



Kugelelektrode / Ball electrode
 3 mm ø

29E-620.05

Die Arthroskopie-Elektroden sind wiederverwendbar (bis zu 5 x) und autoklavierbar (134° C)
 The Arthroscopic Electrodes are reusable (up to 5 times) and autoclavable (134° C)

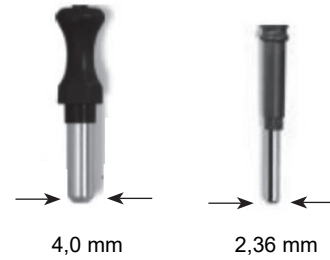

Nadelektrode / Needle electrode

90° abgewinkelt, 1,5 mm, Ø 0,6 mm
 90° angular, 1,5 mm, Ø 0,6 mm



29E-630.01

29E-640.01

Nadelektrode / Needle electrode

90° abgewinkelt, 4,0 mm, Ø 0,6 mm
 90° angled, 4,0 mm, Ø 0,6 mm



29E-630.02

29E-640.02

Tastelektrode / Button electrode

90° abgewinkelt, 4,0 mm, Ø 1,5 mm
 90° angled, 4,0 mm, Ø 1,5 mm



29E-630.04

29E-640.04

Kugelektrode / Ball electrode

Ø 3 mm



29E-630.05

29E-640.05

**Hohlkugel - Elektrode /
Hollow ballelectrode**



29E-630.06

29E-640.06

**Flächenelektrode /
Hollow ballelectrode**



29E-630.07

29E-640.07

**Bürsten - Elektrode /
Brushelectrode**



29E-630.08

29E-640.08

Die Arthroskopie-Elektroden sind wiederverwendbar (bis zu 5 x) und autoklavierbar (134° C)
 The Arthroscopic Electrodes are reusable (up to 5 times) and autoclavable (134° C)

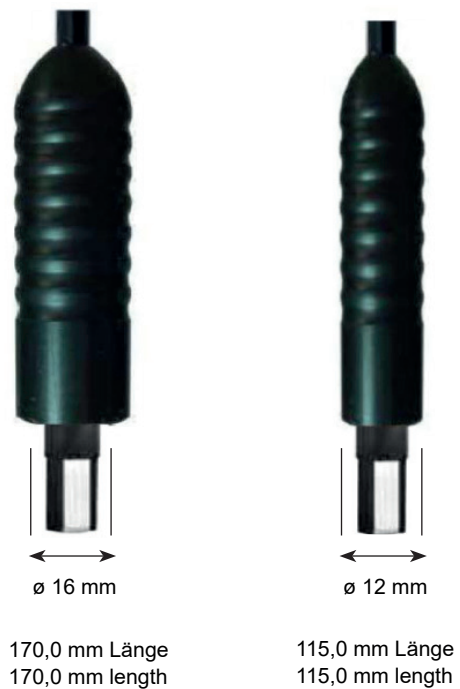

Vaporisationselektrode /
Vaporisationselektrode
 „PHAZER“



29E-650.12

29E-660.12

Hakenelektrode /
Hookelektrode
 1,5 x 0,6 mm



29E-650.13

29E-660.13

Schlingenelektrode /
Slingelettrode
 „COBRA“



29E-650.15

29E-660.15

Die oben aufgeführten bipolaren Arthroskopie-Elektroden dürfen nicht in Verbindung mit Arthrocare-Units verwendet werden.
 The bipolar arthroscopic electrodes mentioned above must not be used in combination with Arthrocare units.



24 cm

19E-300.01

51 cm

19E-300.02**19E-300.15**

Gummilippe Silikon blau
kautschuk lip, blue

**19E-300.16**

Noppenmatte Silikon blau
knobs silikon, blue



Abmessung
 Measurements
 272 x 83 x 44 mm

Katalog Nummer
 Catalog Number
19E-297.01



Abmessung
 Measurements
 272 x 103 x 44 mm

Katalog Nummer
 Catalog Number
19E-297.02

für 2 Optiken, for 2 Telescopes



Abmessung
 Measurements
 452 x 83 x 44 mm

Katalog Nummer
 Catalog Number
19E-298.01

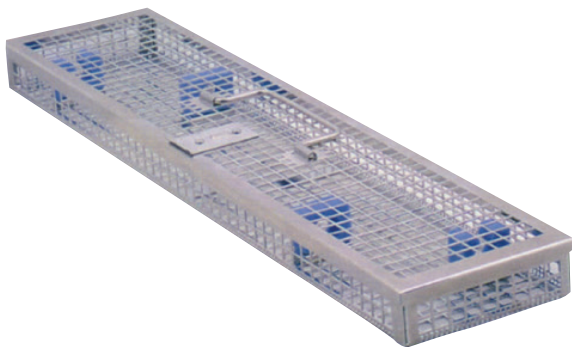

Abmessung
 Measurements
 452 x 103 x 44 mm

Katalog Nummer
 Catalog Number
19E-298.02

für 2 Optiken, for 2 Telescopes

Standard-Container
Standard-Containers

Standard-Container komplett Standard Containers complete

Wanne nicht perforiert
Bottom non perforated



Abmessungen Measurements	Silber Silver	Gold Gold	Rot Red	Blau Blue	Grün Green	Anthrazit Dark Grey
580 x 280 x 200 mm	19E-103.01	19E-103.02	19E-103.03	19E-103.04	19E-103.05	19E-103.06

Wanne perforiert
Bottom perforated



Abmessungen Measurements	Silber Silver	Gold Gold	Rot Red	Blau Blue	Grün Green	Anthrazit Dark Grey
580 x 280 x 200 mm	19E-108.01	19E-108.02	19E-108.03	19E-108.04	19E-108.05	19E-108.06



19E-128.02



Standard-Container
Standard-Containers

Standard-Container komplett
Standard Containers complete

Wanne nicht perforiert
Bottom non perforated



Abmessungen Measurements	Silber Silver	Gold Gold	Rot Red	Blau Blue	Grün Green	Anthrazit Dark Grey
285 x 280 x 200 mm	19E-193.01	19E-193.02	19E-193.03	19E-193.04	19E-193.05	19E-193.06

Wanne perforiert
Bottom perforated



Abmessungen Measurements	Silber Silver	Gold Gold	Rot Red	Blau Blue	Grün Green	Anthrazit Dark Grey
285 x 280 x 200 mm	19E-198.01	19E-198.02	19E-198.03	19E-198.04	19E-198.05	19E-198.06

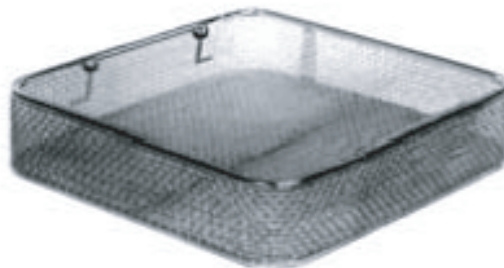

19E-218.02



Deckel und Wanne perforiert
Lid and Bottom perforated







für 1 Optik / for 1 optic	250 x 60 x 50 mm	19E-290.01
für 2 Optiken / for 2 optics	450 x 70 x 70 mm	19E-291.01



für Halogen Licht for Halogen light		Griff grip	Schlauch tube	für Xenon Licht (Glasstab) for Xenon light (glas stick)	
38E-013.01	3,5 x 1800 mm	[Grey bar]	[Black bar]	3,5 x 1800 mm	38E-113.01
38E-023.01	3,5 x 2300 mm			3,5 x 2300 mm	38E-123.01
38E-033.01	3,5 x 3000 mm			3,5 x 3000 mm	38E-133.01
38E-014.01	4,8 x 1800 mm			4,8 x 1800 mm	38E-114.01
38E-024.01	4,8 x 2300 mm			4,8 x 2300 mm	38E-124.01
38E-034.01	4,8 x 3000 mm			4,8 x 3000 mm	38E-134.01
38E-013.02	3,5 x 1800 mm	[Grey bar]	[Blue bar]	3,5 x 1800 mm	38E-113.02
38E-023.02	3,5 x 2300 mm			3,5 x 2300 mm	38E-123.02
38E-033.02	3,5 x 3000 mm			3,5 x 3000 mm	38E-133.02
38E-014.02	4,8 x 1800 mm			4,8 x 1800 mm	38E-114.02
38E-024.02	4,8 x 2300 mm			4,8 x 2300 mm	38E-124.02
38E-034.02	4,8 x 3000 mm			4,8 x 3000 mm	38E-134.02
38E-013.03	3,5 x 1800 mm	[Grey bar]	[Orange bar]	3,5 x 1800 mm	38E-113.03
38E-023.03	3,5 x 2300 mm			3,5 x 2300 mm	38E-123.03
38E-033.03	3,5 x 3000 mm			3,5 x 3000 mm	38E-133.03
38E-014.03	4,8 x 1800 mm			4,8 x 1800 mm	38E-114.03
38E-024.03	4,8 x 2300 mm			4,8 x 2300 mm	38E-124.03
38E-034.03	4,8 x 3000 mm			4,8 x 3000 mm	38E-134.03
38E-013.04	3,5 x 1800 mm	[Grey bar]	[Grey bar]	3,5 x 1800 mm	38E-113.04
38E-023.04	3,5 x 2300 mm			3,5 x 2300 mm	38E-123.04
38E-033.04	3,5 x 3000 mm			3,5 x 3000 mm	38E-133.04
38E-014.04	4,8 x 1800 mm			4,8 x 1800 mm	38E-114.04
38E-024.04	4,8 x 2300 mm			4,8 x 2300 mm	38E-124.04
38E-034.04	4,8 x 3000 mm			4,8 x 3000 mm	38E-134.04







Lichtquelle
 Standard
 Source of light
 standard

Storz		38E-200.01
ACM / Stryker / Standard		38E-200.02
Olympus neu		38E-200.03
Wolf		38E-200.04
Olympus alt		38E-200.05



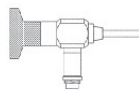

Lichtquelle
 Glasstab/Xenon
 Source of light
 glas stick/xenon

Storz		38E-200.21
ACM / Stryker / Standard		38E-200.22
Olympus neu		38E-200.23
Wolf		38E-200.24
Olympus Sondermodell		38E-200.25



Adapter Instrumentenseite
 Adapter instruments side

Storz		38E-201.01
Wolf		38E-201.02
Olympus / ACM / Stryker		38E-201.03

**HBS und Snap-off-Schrauben Implantations-
und Instrumenten-Set**

HBS and Snap-off Screw Implant and
Instrument Set

Best.nr./Cat.no. T-4700



Set beinhaltet / Set includes

Kat.nr. Cat.no.	Instrumente für HBS/Snap-off Schrauben-Set Instruments for HBS/Snap-off Screw Set	Stück pieces
4-739	Führungsdraht / Guide Wire Ø 1.0 mm, Länge / length 80 mm	4
4-740	Kanülierter Bohreraufsatz / Cannulated Drill Bit Ø 2.1 mm / 3.3 mm	1
4-741	Kanülierter Bohreraufsatz / Cannulated Drill Bit Ø 2.1 mm / 3.3 mm	1
4-742	Messlehre für Schraubenlänge / Screw Length Gauge	1
4-743	Messhülse für Führungsdraht / Measuring Sleeve for Guide Wire	1
4-744	Kannülierter Schraubendreher / Cannulated Screwdriver hexagonal 2.0 mm	1
4-745	Schraubendreher für Snap-off Schrauben / Screwdriver for Snap-off Screws	1
4-184	Schraubenhaltepinzette / Screw Forceps	1
Kat.nr. Cat.no.	HBS-Kompressionsschraube, Ø 3.0 mm, kanüliert HBS Compression Screw, Ø 3.0 mm, cannulated	Stück pieces
4-712	Länge / length 12 mm, Titan / Titanium	4
4-714	Länge / length 14 mm, Titan / Titanium	4
4-716	Länge / length 16 mm, Titan / Titanium	4
4-718	Länge / length 18 mm, Titan / Titanium	4
4-720	Länge / length 20 mm, Titan / Titanium	4
4-722	Länge / length 22 mm, Titan / Titanium	4
4-724	Länge / length 24 mm, Titan / Titanium	4
4-726	Länge / length 26 mm, Titan / Titanium	4
4-728	Länge / length 28 mm, Titan / Titanium	4
4-730	Länge / length 30 mm, Titan / Titanium	4
Kat.nr. Cat.no.	Snap-off Schraube, Ø 2.0 mm, Titan Snap-off Screw, Ø 2.0 mm, Titanium	Stück pieces
4-760	Länge / length 11 mm, Titan / Titanium	4
4-762	Länge / length 12 mm, Titan / Titanium	4
4-764	Länge / length 13 mm, Titan / Titanium	4
4-766	Länge / length 14 mm, Titan / Titanium	4

Sterilisationsbehälter für Set T-4700

310 x 190 x 65 mm, Deckel und Boden perforiert

Sterilization Container for Set T-4700

310 x 190 x 65 mm, lid and bottom perforated

Kat.nr./Cat.no. 19E-276.01

Der Sterilisationsbehälter ist **nicht** im Lieferumfang des Sets T-4700 enthalten.

The Sterilization Container is **not** included in Set T-4700.



Ø 3.0 mm

Kat.nr. Cat.no.	HBS-Kompressionsschraube, Ø 3.0 mm, kanüliert HBS Compression Screw, Ø 3.0 mm, cannulated
4-712	Länge / length 12 mm, Titan / Titanium
4-714	Länge / length 14 mm, Titan / Titanium
4-716	Länge / length 16 mm, Titan / Titanium
4-718	Länge / length 18 mm, Titan / Titanium
4-720	Länge / length 20 mm, Titan / Titanium
4-722	Länge / length 22 mm, Titan / Titanium
4-724	Länge / length 24 mm, Titan / Titanium
4-726	Länge / length 26 mm, Titan / Titanium
4-728	Länge / length 28 mm, Titan / Titanium
4-730	Länge / length 30 mm, Titan / Titanium

Die Kompressionsschraube ist mit Hilfe des Führungsdrahts leicht einzusetzen und erlaubt eine effiziente Kompression durch einem gewindefreien Mittelteil und eine schnelle interne Befestigung durch zwei verschiedene selbstschneidende Gewinde mit unterschiedlichen Steigungswinkeln. Der distale Steigungswinkel ermöglicht die Kompression in 1 mm-Schritten.

Indikationen

- Distale und proximale metatarsale Osteotomien
- SCARF Osteotomie
- Uni- und biokortikale interne Befestigung (ex.: scaphoid)
- Verbindung von kleinen Knochen

The Compression Screw is easy to insert by guide wire and allows efficient compression by an unthreaded intermediate section and quick internal fixation by two separate self-tapping threads with different pitches. The distal pitch provides compression intervals of 1 mm.

Indications

- Distal and proximal metatarsal osteotomies
- SCARF osteotomy
- Uni- und biocortical internal fixation (ex.: scaphoid)
- Small bone fusion



Kat.nr. Cat.no.	Snap-off Schraube, Ø 2.0 mm Snap-off Screw, Ø 2.0 mm
4-760	Länge / length 11 mm, Titan / Titanium
4-762	Länge / length 12 mm, Titan / Titanium
4-764	Länge / length 13 mm, Titan / Titanium
4-766	Länge / length 14 mm, Titan / Titanium

Die Snap-off Schraube sorgt für ausgezeichnete Befestigung: Sie spart Zeit (kein Führungsbohrloch notwendig), ist einfach anzuwenden, sicher (glatter Bruch), genau (Führungspunkt) und effizient (Selbstkompression).

Die Snap-off Schraube besteht aus zwei Teilen: Die implantierbare Schraube und für die feste Verankerung den Einführer, der kraftvolles Einschrauben erlaubt. Die Schraube hat einen flachen Kopf mit drei Kerben für besseren Halt, einen gewindefreien Mittelteil zur Selbstkompression und ein selbstschneidendes Gewinde.

Indikationen

- Weil Osteotomie
- Unikortikale interne Befestigung

The Snap-Screw provides superior fixation: It saves time (no pilot drill hole needed), is easy to use, safe (clean break), accurate (guide point) and efficient (self-compression).

The Snap-off Screw consists of two parts: The implantable screw and the firm anchorage inserter which allows powered insertion. The screw has a low profile head with three notches for positive grip, an unthreaded section for self-compression and a self-drilling, self-tapping thread.

Indications

- Weil osteotomy
- Unicortical internal fixation

Schraubendreher für Snap-off Schrauben

Screw Driver for Snap-off Screws

Kat.nr./Cat.no. 4-745



Schraubenthaltepinzette

Screw Forceps

Kat.nr./Cat.no. 4-184



**Führungsdraht / Guide Wire**

Ø 1.0 mm, Länge / length 80 mm

Kat.nr./Cat.no. 4-739**Kanülierter Bohraufsatz / Cannulated Drill Bit**

Ø 2.1 mm / 3.3 mm

Kat.nr./Cat.no. 4-740**Kanülierter Bohraufsatz / Cannulated Drill Bit**

Ø 2.1 mm

Kat.nr./Cat.no. 4-741**Messlehre für Schraubenlänge / Screw Length Gauge****Kat.nr./Cat.no. 4-742****Messhülse für Führungsdraht / Measuring Sleeve for Guide Wire**

für Führungsdraht Kat.nr. 4-739 HBS / for Guide Wire Cat.no. 4-739 HBS

Kat.nr./Cat.no. 4-743**Kanülierter Schraubendreher / Cannulated Screwdriver**

hexagonal 2.0 mm / hexagonal 2.0 mm

Kat.nr./Cat.no. 4-744**Verbrügge**











Knochenhaltezange 175 mm

Bone Holding Forceps 175 mm

Kat.nr./Cat.no. 16E-039**Inge**

160 mm

Kat.nr./Cat.no. 13-3250

	ab Seite / from Side	
Trokarhülsen, Trokare, Obturatoren Sheaths, Trocars, obturators Camisas para trócares, Trócares, Obturadores Douilles de trocart, Trocarts, Obturateurs	32E-3	
Arthroskope Arthroscopes Artroscopios Arthroscopes	32E-13	
Arthroskopie Handinstrumente Handle with Stems Adaptadores Adattatores	32E-15	
Hakenstanzen, Hakenschere Hook Punches, Hook Scissors Pinzas cortantes, Tijeras forma gancho Pincas à crochet, Ciseaux crochets	32E-22	
Monopolare Athroskopie-Elektroden Monopolar Athroscopy Electrodes Unipolar Electrodes Unipolare Electrodes	32E-47	
Bipolare Athroskopie-Elektroden Bipolar Athroscopy Electrodes Bipolar Electrodes Bipolare Electrodes	32E-49	
Instrumentenfixierungs-Rack fixing rack Fijación de instrumentos rack Fissaggio strumenti portaoggetti	32E-50	
Optik Siebkörbe Optic trays bandejas para óptica ottica cestino de vaglio	32E-51	
Container containers contenedor contenitore	32E-52	
Kaltlichtkabel und Zubehör Fibre Optic Cables and Accessories Cables de luz fría y accesorios óptica Câbles de Lumière Froide	32E-55	
HBS und Snap-off Schrauben-Set HBS and Snap-off Screw Set HBS y Snap-off Screw Set HBS et Snap-off Screw Set	32E-57	
Inhaltsübersicht Table of Contents el indice indice	32E-61	

Technische Änderungen vorbehalten
Technical features are subject to change
Cambios técnicos reservados
Ci riserviamo il diritto di modifiche tecniche



erbrich - instrumente GmbH
Eugenstr. 33 • D-78532 Tuttlingen
Tel.: +49 74 61 / 96 57 30
Fax: +49 74 61 / 96 57 320
E-mail: info@erbrich-instrumente.de
Website: www.erbrich-instrumente.de